

COMPLEMENTARY PRODUCTS

WATER GUNS

UMV

The UMV series washgun has been designed primarily to avoid hot water waste, while assuring very comfortable operation conditions. Its thick rubber casing not only effectively protects the operator's hand from the discomfort of hot water but also assures an excellent protection in case the washgun is dropped or falls to the ground since it avoids any damage to the tiles or the equipment. The careful design, mainly used for the food industry, also includes a grease and detergent resistant quality rubber, plus a blue colour has been chosen as a visual aid to be seen clearly against a white or clear foreground. The trigger is lined too, and can be held in the open position by means of a lock-ring. The spray pattern can be adjusted continuously between a closed straight jet to a wide angle spray, so that the proper spray pattern can be chosen for each individual job.

Materials

Body	T2 Brass casting, chrome plated
	B3 AISI 316 Stainless Steel
Lining	E0 EPDM
Stem	B3 AISI 316 Stainless steel
Trigger	B3 AISI 316 Stainless steel, rubber lined

LT	80° C
LP	25 bar
LQ	21 lpm @ 3 bar UMV 2210
	61 lpm @ 3 bar UMV 2211

Hose shank	13 mm - 1/2" hose fitting
Weight	0.9 kg

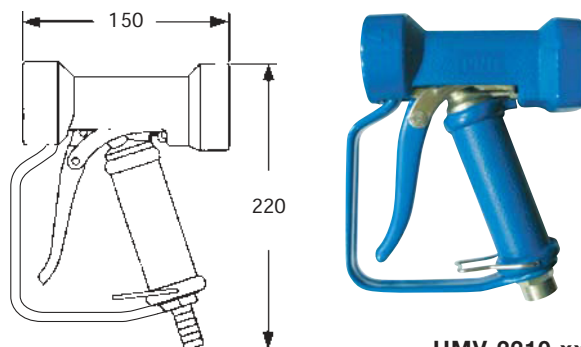

UMV 2210 xx

The versatility of this washgun is enhanced from the additional model UMV 2211, which can be fitted with nozzles or different lances through its 1/2" female thread. The three different lance models shown are easily fitted to the gun body with a 1/2" male nipple and offer the following choices of operation:

- 1 Foaming machines and equipment prior to washing operations. The foam lance comes with a quick connect female coupling, and a matching coupling must be fitted at the gun outlet.
- 2 General purpose 1/4" fem thread outlet, 1/4" male thread inlet. Available both with heat protection sleeve, or zinc-plated steel. The general purpose lance needs a connection nipple 1/4" fem to 1/2" male to be fitted on the gun. Please see the complete washgun and components codes below.

Complete guns







UMV 2210 xx	Standard, adjustable jet
UMV 220A xx	With foam lance
UMV 220B xx	With 1/4" fem outlet, bare lance
UMV 220C xx	With 1/4" fem outlet, heat protected lance

Please complete product codes, ending with (xx), filling in the code of required material eg **T2**, chrome plated brass, or **B3** for AISI Stainless steel 316.

Single components

UMV 2211 xx	With 1/2" female quick thread, without lance
XUM V001 B3	Foam lance
XUM V002 B3	Quick connect coupling for foam lance, 1/2" M
XUM V003 B3	Universal lance, 1/4" F out, heat protection
XUM V004 B3	Universal lance, 1/4" F out, zinc-plated steel
XUM V005 T2	Nipple, 1/4" F - 1/2" M, chrome plated brass



						
UMV 2211 xx	+	XUM V002 B3	+	XUM V001 B3	=	UMV 220A T2
						
	+	XUM V005 T2	+	XUM V004 B3	=	UMV 220B T2
						
	+	XUM V005 T2	+	XUM V003 B3	=	UMV 220C T2